

Trinkwasserspeicher für Wärmepumpe

Domestic hot water tank for heat pump

Ballon eau chaude sanitaire pour pompe à chaleur

Serbatoio di accumulo acqua calda sanitaria per pompa di calore

BE- 200-2000

Emailliert
Enamelled | Émaillés | Smaltato

DIN

EN 12897

EnEV 730.02

ErP 812/2013

ErP 814/2013

DIN 4753

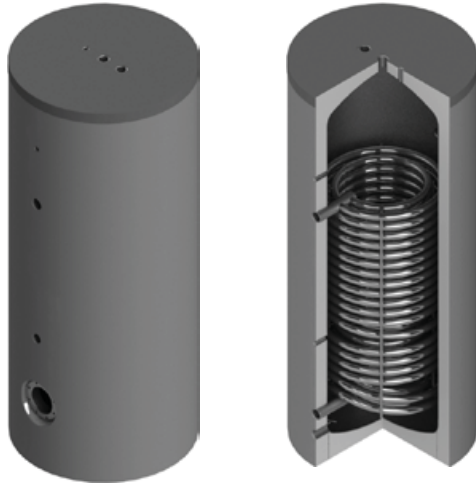

Bauart

Design | Structure | Struttura

Die Speicher werden aus hochwertigem Stahl nach EN 10025 gefertigt.

Die Speicher werden nach EN 12897:2014 dimensioniert, gefertigt und zertifiziert.

EN The storage tanks are made from high quality steel in accordance with EN 10025.

The storage tanks are designed, manufactured and certified in accordance with EN 12897:2014.

FR Les ballons sont fabriqués en acier de grande qualité selon la norme EN 10025.

Les ballons sont dimensionnés, fabriqués et certifiés selon la norme EN 12897:2014.

IT Gli accumulatori sono realizzati in acciaio pregiato secondo la norma EN 10025.

Gli accumulatori sono dimensionati, costruiti e certificati secondo la norma EN 12897:2014.

Lieferumfang

Delivery | Livraison | Consegna

	l	mm		Art. Nr.
Bedienungsanleitung Operation manual Mode d'emploi Istruzioni per l'uso			1 x	
Thermometer mit Tauchhülse Thermometer with immersion sleeve Thermomètre avec manchon d'immersion Termometro con manicotto ad immersione	≤ 600	100	1 x	6001150100
	≥ 800	200	1 x	6001150200
Tauchhülse Immersion sleeve Manchon d'immersion Manicotto ad immersione		1000	1 x	6001181011
Magnesium Schutzanode Magnesium protective anode Anode protectrice de magnésium Anodo protettivo in magnesio	200 – 300	750	1 x	6001140750
	400	1000	1 x	6001141000
	500 – 800	520	1 x	6001140520
		1000	1 x	6001141000
	1000 – 1500	750	1 x	6001140750
		1000	1 x	6001141000
1750 – 2000	1000	2 x	6001141000	
Stellschrauben Adjusting srew Vis de réglage Viti di regolazione	800 – 2000		3 x	6001990018

Schutz vor Korrosion**Anti-corrosion protection | Protection contre la corrosion | Protezione anticorrosiva**

Doppelt gebrannte Zweischicht-Emallierung nach DIN 4753. Grosszügige Magnesium Schutzanode nach DIN 4753-3. Speicher mit separater Isolierung sind aussen mit einem Antikorrosionslack lackiert.

EN Dual-fired two-layer enamelling in accordance with DIN 4753. Generous magnesium protection anode in accordance with DIN 4753-3. Storage tanks with separate insulation are coated on the exterior with an anticorrosion paint.

FR Émaillage bi-couche à double cuisson conforme à la norme DIN 4753. Anode de protection de belle taille en magnésium conforme à la norme DIN 4753-3. Les réservoirs avec isolation séparée sont recouverts à l'extérieur d'une laque anticorrosion.

IT Smaltatura a doppia mano secondo DIN 4753. Anodo protettivo di magnesio in grande quantità secondo DIN 4753-3. Gli accumulatori con isolamento separato sono verniciati esternamente con smalto resistente alla corrosione.

Wärmetauscher**Heat exchanger | Échangeur de chaleur | Scambiatore di calore**

Ein eingeschweisster grossflächiger Wärmetauscher.

EN One welded large-surface heat exchanger.

FR Un échangeur de chaleur grande surface soudé.

IT Uno scambiatore di calore saldato di grande superficie.

Isolierung**Insulation | Isolation | Isolamento****PU-Hartschaum**

60 mm PU-Hartschaum fix geschäumt. Skaimantel 5 mm mit Reissverschluss vormontiert, inklusive Rosetten und Abdeckhaube. Brandschutzklasse B2. Silber. Weitere Farben nach Absprache.

UltraShell

Mehrschicht-Isolierung aus 80 mm Hartschaum + 20 mm Faservlies. PS-Mantel und Hakenleiste, inklusive Rosetten und Abdeckhaube. Brandschutzklasse B2. Silber. Lose geliefert.

EN Rigid polyurethane foam

60 mm rigid polyurethane foam. Skai jacket 5 mm with zip preassembled, including cover plates and hood. Fire-resistance rating B2. Silver. Other colours on request.

FR Mousse solidifiée PU

60 mm de mousse dure PU Enveloppe en skai de 5 mm préinstallée avec fermeture à glissière, y compris rosettes et capot. Classe allemande de protection incendie B2. Argent. Autres couleurs après concertation.

IT Schiuma PU rigida

60 mm di schiuma rigida di poliuretano fissa. Mantello in skai da 5 mm pre-assemblato con cerniera, dotato di rosette e calotta di copertura. Classe di resistenza antincendio B2. Argento. Altri colori su richiesta.

UltraShell

Multilayer insulation made of 80 mm rigid foam + 20 mm fibre fleece. PS jacket and hook rack, including cover plates and hood. Fire-resistance rating B2. Silver. Supplied loose.

UltraShell

Isolation multicouches constituée de 80 mm de mousse dure + 20 mm de tissu fibreux. Enveloppe en PS équipée d'un support à crochets préinstallé, y compris rosettes et capot. Classe allemande de protection incendie B2. Argent. Livrée non montée.

UltraShell

Isolamento multistrato con 80 mm di schiuma rigida + 20 mm di tessuto non tessuto. Mantello in PS e barra con ganci, rosette e calotta di copertura incluse. Classe di resistenza antincendio B2. Argento. Consegna sfusa.

≤ 600 L
PU-Hartschaum

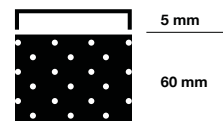

800 – 2000 L
UltraShell

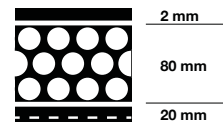

Trinkwasserspeicher für Wärmepumpe

Domestic hot water tank for heat pump

Ballon eau chaude sanitaire pour pompe à chaleur

Serbatoio di accumulo acqua calda sanitaria per pompa di calore

BE- 200-2000

Emailliert
Enamelled | Émaillés | Smaltato

		200	300	400	500	600	800	1000	1250	1500	1750	2000
Inhalt Capacity Contenance Contenuto	l	216	304	408	498	562	830	925	1226	1413	1728	1926
Ø mit Isolierung with insulation avec isolation con isolamento	mm	600	650	750	750	750	990	990	1100	1200	1300	1300
Ø ohne Isolierung without insulation sans isolation senza isolamento	mm	-	-	-	-	-	790	790	900	1000	1100	1100
Höhe mit Isolierung Height with insulation Hauteur avec isolation Altezza con isolamento	mm	1170	1570	1500	1800	2000	1990	2190	2240	2120	2150	2350
Kippmass Tilted dimension Cote de basculement Altezza in raddrizzamento	mm	1340	1700	1680	1950	2140	1990	2190	2260	2120	2200	2355
Betriebsdruck Heizung Heater operating pressure Pression de service du chauffage Pressione d'esercizio riscaldamento	bar	6	6	6	6	6	6	6	6	6	6	6
Betriebsdruck Wasser Water operating pressure Pression de service de l'eau Pressione d'esercizio acqua	bar	6	6	6	6	6	6	6	6	6	6	6
Prüfdruck Test pressure Pression test Pressione di collaudo	bar	12	12	12	12	12	12	12	12	12	12	12
max. Betriebstemperatur max. operating temperature Temp. de service max. Temperatura max. d'esercizio	°C	95	95	95	95	95	95	95	95	95	95	95
Gewicht Weight Poids Peso	kg	114	141	179	217	228	291	308	375	445	476	502
Art.Nr. Part no. Réf. Art.n.	100104...	0200	0300	0400	0500	0600	0800	1000	1250	1500	1750	2000
Isolierung Insulation Isolation Isolamento		60 mm fix eingeschäumt Fixed with foam Enrobage mousse fixe Schiuma rigida fissa					UltraShell 100					
Wärmeverlust Heat losses Pertes thermiques Perdita di calore	kWh/24h	0.98	1.40	1.64	1.89	2.03	3.26	3.44	3.6	3.77	4.01	4.38
ErP-Klasse ErP class Classe ErP Classe ErP		A	B	B	B	B	C	C	C	C	C	C
Gewicht Weight Poids Peso	kg	-	-	-	-	-	35	40	45	50	55	60
Art.Nr. Part no. Réf. Art.n.	300104...	-	-	-	-	-	0809	1009	1259	1509	1759	2009

		200	300	400	500	600	800	1000	1250	1500	1750	2000
Glattrohrwärmetauscher Heating coil Échangeurs de chaleur Serpentino	m ²	2.5	3.2	4.3	5.4	5.4	6.0	6.0	7.7	8.5	9.7	9.7
Inhalt Glattrohrwärmetauscher Heating coil capacity Contenance échangeurs de chaleur Contenuto serpentino	l	15.9	20.4	27.5	35.2	35.2	39.2	39.2	66.4	76.5	83.8	83.8
Durchflussmenge Throughput Débit Portata flusso	m ³ / h	2.0	2.5	3.0	4.0	4.0	4.0	4.0	4.1	4.5	5.2	5.2
Druckverlust Pressure loss Perte de charge Perdita di pressione	mbar	20	20	40	50	50	60	60	30	30	60	60
Dauerleistung Continuous output Régime permanent Potenza continua 10°C / 45°C / 50°C	l / h	153	197	270	331	331	368	368	472	521	595	595
max. Glattrohrwärmetauscherleistung max. heating coil output Puissance max. du échangeurs de chaleur Potenza max. serpentino	kW	6.0	8.0	11.0	13.5	13.5	15.0	15.0	19.0	21.0	24.0	24.0
Durchflussmenge Throughput Débit Portata flusso	m ³ / h	3.2	4.1	5.6	6.8	6.8	7.6	7.6	9.8	10.8	12.3	12.3
Druckverlust Pressure loss Perte de charge Perdita di pressione	mbar	30	60	140	280	280	370	370	170	270	440	440
Dauerleistung Continuous output Régime permanent Potenza continua 10°C / 45°C / 80°C	l / h	905	1159	1558	1957	1957	2171	2171	2790	3080	3515	3515
max. Glattrohrwärmetauscherleistung max. heating coil output Puissance max. du échangeurs de chaleur Potenza max. serpentino	kW	36.8	47.1	63.3	79.5	79.5	88.4	88.4	113.4	125.2	142.8	142.8

Trinkwasserspeicher für Wärmepumpe

Domestic hot water tank for heat pump

Ballon eau chaude sanitaire pour pompe à chaleur

Serbatoio di accumulo acqua calda sanitaria per pompa di calore

BE- 200-2000

Emailliert
Enamelled | Émaillés | Smaltato

200 – 600

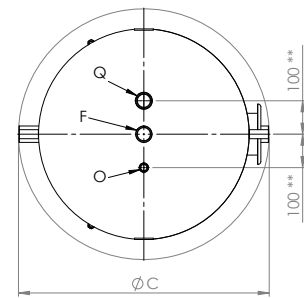
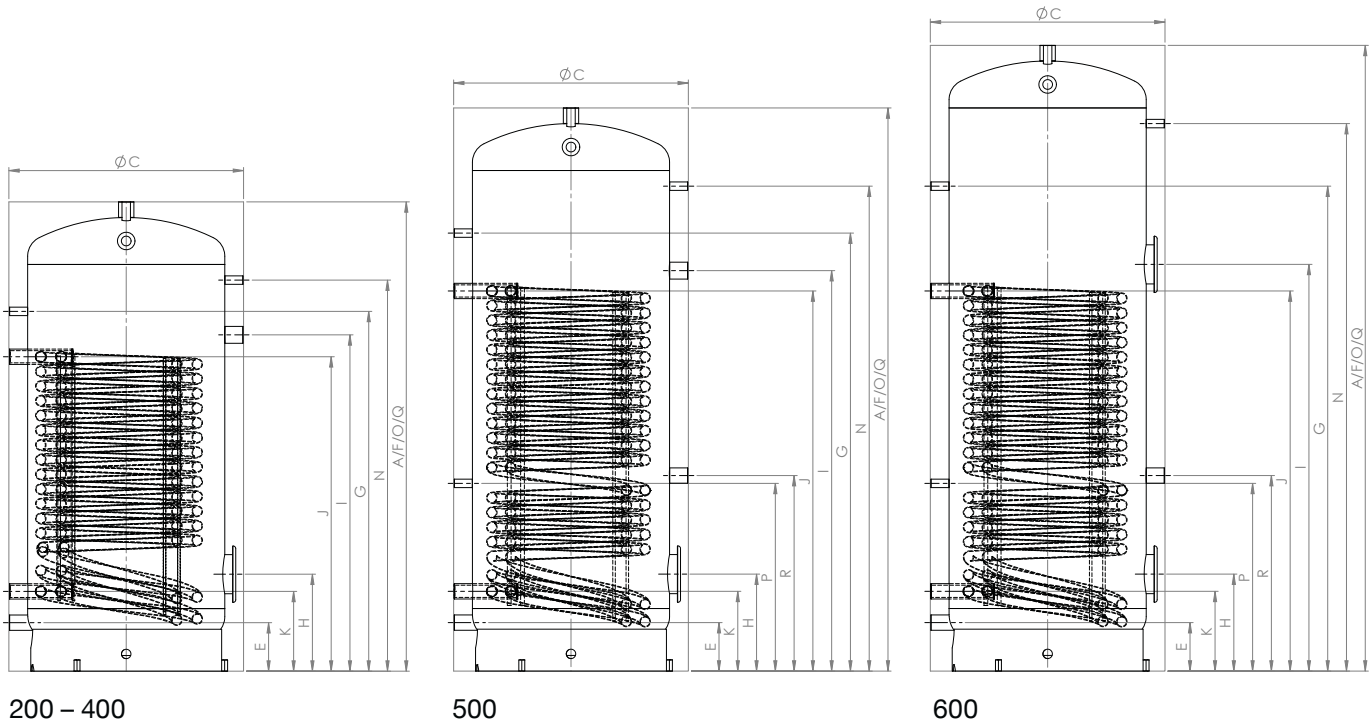

** 200 – 300: 80 mm

	Verwendung Usage Utilisation Uso	Dimension Dimension Dimension Dimensione	200	300	400	500	600
A	Höhe Height Hauteur Altezza	○ – mm	1170	1570	1500	1800	2000
C	Ø	○ – mm	650	650	750	750	750
E	Kaltwasser Cold water Eau froide Acqua fredda	⇕ – mm	140	140	155	155	155
		G" – mm	1 ¼"	1 ¼"	1 ¼"	1 ¼"	1 ¼"
F	Warmwasser Hot water Eau chaude Acqua calda	⇕ – mm	1170	1570	1500	1800	2000
		G" – mm	1 ¼"	1 ¼"	1 ¼"	1 ¼"	1 ¼"
G	Zirkulation Circulation Circulation Circolazione	⇕ – mm	890	1200	1150	1400	1550
		G" – mm	½"	½"	½"	½"	½"
H	Flansch unten Flange below Bride du bas Flangia inferiore	⇕ – mm	295	295	310	310	310
		Ø – mm	180/120	180/120	180/120	180/120	180/120
I	Flansch oben / Muffe E-Heizung Flange above / Sleeve heater Bride du haut / Manchon chauffage Flangia superiore / Manicotto riscaldatore	⇕ – mm	840	990	1075	1280	1300
		Ø – mm	1 ½"	1 ½"	1 ½"	1 ½"	180/120
J	VL Glattrohrwärmetauscher unten Bottom heating coil Échangeurs de chaleur bas Serpentino inferiore	⇕ – mm	770	920	1005	1215	1215
		G" – mm	1 ¼"	1 ¼"	1 ¼"	1 ¼"	1 ¼"
K	RL Glattrohrwärmetauscher unten Bottom heating coil Échangeurs de chaleur bas Serpentino inferiore	⇕ – mm	240	240	255	255	255
		G" – mm	1 ¼"	1 ¼"	1 ¼"	1 ¼"	1 ¼"
N	Thermometer Thermometer Thermomètre Termometro	⇕ – mm	950	1350	1250	1550	1750
		G" – mm	½"	½"	½"	½"	½"
O	Fühlerhülse Sensor sleeve Manchon de sonde Manicotto sensore	⇕ – mm	1170	1570	1500	1800	2000
		G" – mm	½"	½"	½"	½"	½"
P	Fühler Sensor Sonde Sensor	⇕ – mm	-	-	-	600	600
		G" – mm	-	-	-	½"	½"
Q	Magnesiumanode Magnesium anode Anode de magnésium Anodo in magnesio	⇕ – mm	1170	1570	1500	1800	2000
		G" – mm	1 ¼"	1 ¼"	1 ¼"	1 ¼"	1 ¼"
R	Magnesiumanode Magnesium anode Anode de magnésium Anodo in magnesio	⇕ – mm	-	-	-	625	625
		G" – mm	-	-	-	1 ¼"	1 ¼"

Trinkwasserspeicher für Wärmepumpe

Domestic hot water tank for heat pump

Ballon eau chaude sanitaire pour pompe à chaleur

Serbatoio di accumulo acqua calda sanitaria per pompa di calore

BE- 200-2000

Emailliert
Enamelled | Émaillés | Smaltato



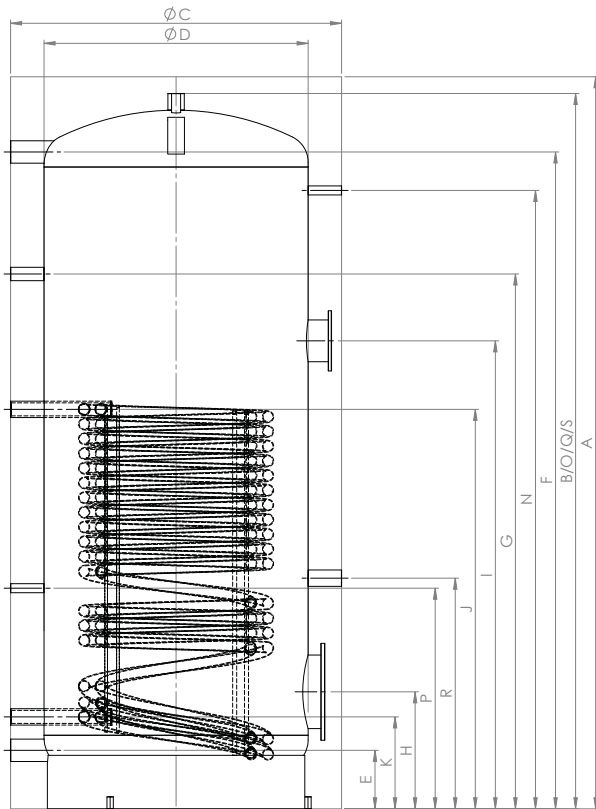



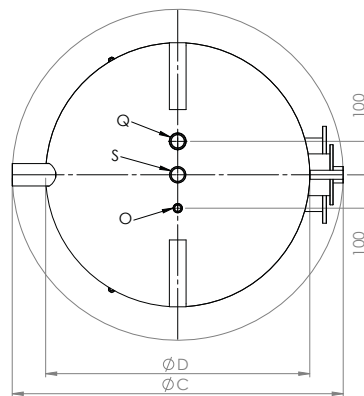









800 – 2000



800 – 2000



800 – 2000

	Verwendung Usage Utilisation Uso	Dimension Dimension Dimension Dimensione	800	1000	1250	1500	1750	2000
A	Höhe Height Hauteur Altezza	 - mm	1990	2190	2240	2120	2150	2350
B		 - mm	1940	2140	2190	2070	2100	2300
C	Ø	 - mm	990	990	1100	1200	1300	1300
D		 - mm	790	790	900	1000	1100	1100
E	Kaltwasser Cold water Eau froide Acqua fredda	 - mm	175	175	200	220	235	235
		G"	2"	2"	2"	2"	2"	2"
F	Warmwasser Hot water Eau chaude Acqua calda	 - mm	1765	1965	1990	1730	1730	1930
		G"	2"	2"	2"	2"	2"	2"
G	Zirkulation Circulation Circulation Circolazione	 - mm	1400	1600	1600	1450	1500	1650
		G"	1"	1"	1"	1"	1"	1"
H	Flansch unten Flange below Bride du bas Flangia inferiore	 - mm	350	350	400	470	480	480
		Ø - mm	290/220	290/220	290/220	290/220	290/220	290/220
I	Flansch oben Flange above Bride du haut Flangia superiore	 - mm	1400	1400	1400	1400	1420	1500
		Ø - mm	180/120	180/120	180/120	180/120	180/120	180/120
J	VL Glattröhrwärmetauscher Heating coil Échangeurs de chaleur Serpentino	 - mm	1195	1195	1320	1310	1310	1310
		G"	1 ¼"	1 ¼"	1 ½"	1 ½"	1 ½"	1 ½"
K	RL Glattröhrwärmetauscher Heating coil Échangeurs de chaleur Serpentino	 - mm	275	275	320	360	360	360
		G"	1 ¼"	1 ¼"	1 ½"	1 ½"	1 ½"	1 ½"
N	Thermometer Thermometer Thermomètre Termometro	 - mm	1650	1850	1900	1750	1750	1950
		G"	½"	½"	½"	½"	½"	½"
O	Fühlerhülse Sensor sleeve Manchon de sonde Manicotto sensore	 - mm	1940	2140	2190	2070	2100	2300
		G"	½"	½"	½"	½"	½"	½"
P	Fühler Sensor Sonde Sensor	 - mm	660	660	680	590	600	600
		G"	½"	½"	½"	½"	½"	½"
Q	Magnesiumanode Magnesium anode Anode de magnésium Anodo in magnesio	 - mm	1940	2140	2190	2070	2100	2300
		G"	1 ¼"	1 ¼"	1 ¼"	1 ¼"	1 ¼"	1 ¼"
R	Magnesiumanode Magnesium anode Anode de magnésium Anodo in magnesio	 - mm	690	690	710	800	810	810
		G"	1 ¼"	1 ¼"	1 ¼"	1 ¼"	1 ¼"	1 ¼"
S	Anschluss oben Connection top Lien ci-dessus Collegamento sopra	 - mm	1940	2140	2190	2070	2100	2300
		G"	1 ¼"	1 ¼"	1 ¼"	1 ¼"	1 ¼"	1 ¼"